

A50

一体型 3°

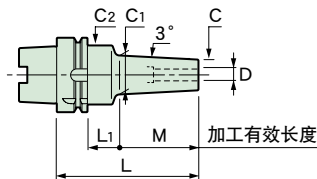

HEATROBO电磁 1200S
(HRD-01S-230AS)
电磁式加热器对应表

[○] 可加热 [×] 不可加热

■标准附属品
●冷却液导管(固定式)→P.186

■备考
●可对应可动式冷却液导管→P.186

■注意事项
●刀具安装...插入刀具时,请务必将刀具插入比安全记号更深的位置。
●A50M 倒扣部分尺寸同规格不同。请注意是否同 ATC 臂发生干涉。

壁厚 t

安全记号

最短夹持长度 H

刀具最大插入长度 h

型号	φD	φC	t	L	M	L ₁	φC ₁	φC ₂	H	h	Kg	N	S	缩略图					
A50-SLSA 3- 95-M42	3	6	1.5	95	42	27	10.4	25	9	71	0.5	5.8	9.1	○	1				
-125-M42				125		57				101					0.6	6.5	9.8	2	
-SLRA 3- 75-M22	3	7.5	2.25	75	22	27	9.8	25	9	51	0.5	6.2	2.8	○	3				
- 95-M42				95						42					71		6.6	5.3	4
-125-M42				125						57					101	0.6	7.3	6	5
A50-SLSA 4- 95-M42	4	7	1.5	95	42	27	11.4	25	12	71	0.5	7	7.2	○	6				
-125-M42				125		57				101					0.6	7.7	7.9	7	
-SLRA 4- 75-M22	4	10	3	75	22	27	12.3	25	12	51	0.5	6.3	1.7	○	8				
- 95-M42				95						42					71		7	3.1	9
-125-M42				125						57					101	0.6	7.7	3.8	10
A50-SLSA 6- 95-M42	6	9	1.5	95	42	27	13.4	25	18	71	0.5	7.3	4.8	○	11				
-125-M42				125		57				101					0.6	8	5.6	12	
-SLRB 6- 75-M22	6	14	4	75	22	27	16.3	32	18	50	0.5	7.2	1	○	13				
- 95-M42				95						42					70	0.6	8.9	1.6	14
-125-M42				125						57					100	0.7	10.2	1.9	15
A50-SLSA 8- 95-M42	8	11	1.5	95	42	27	15.4	25	24	71	0.5	9.3	3.4	○	16				
-125-M42				125		57				101					0.6	11.8	4.4	17	
-SLRB 8- 75-M22	8	18	5	75	22	27	20.3	32	24	50	0.6	7.9	0.7	×	18				
- 95-M42				95						42					70		10.5	1.1	19
-125-M42				125						57					100	0.8	11.8	1.5	20
A50-SLSA10- 95-M42	10	13	1.5	95	42	27	17.4	25	30	71	0.5	10.7	2.6	○	21				
-125-M42				125		57				101					0.6	12.1	3.7	22	
-SLRB10- 75-M22	10	22	6	75	22	27	24.3	32	30	50	0.6	8.3	0.6	×	23				
- 95-M42				95						42					70		11.9	0.9	24
-125-M42				125						57					100	0.8	13.3	1.3	25
A50-SLRB12- 75-M22	12	26	7	75	22	27	28.3	42	30	52	0.7	6.2	0.4	×	26				
- 95-M42				95						42					72	0.8	6.3	0.6	27
-125-M42				125						57					98	1	22.9	0.8	28
A50-SLRB16- 75-M22	16	32	8	75	22	27	34.3	42	32	52	0.7	6.3	0.4	○	29				
-105-M22				105		57				78					1	19	0.5	30	
A50M-SLRB20- 75-M22*	20	38	9	75	22	27	40.3	49	40	51	0.8	6.4	0.3	○	31				
-105-M22*				105		57				76					1.2	15.1	0.4	32	

※ 使用电磁5000S加热器对SLRB20加热时,所使用加热线圈号码不同。请使用加热线圈No.4进行加热。

■主轴锥孔用 清洁工具
STAR DUST

型号
CLT-A50-G2

⊕ P.194

SUGINO SC Dual
HORKOS NJ 50
MAKINO J J3 / L2

φ3

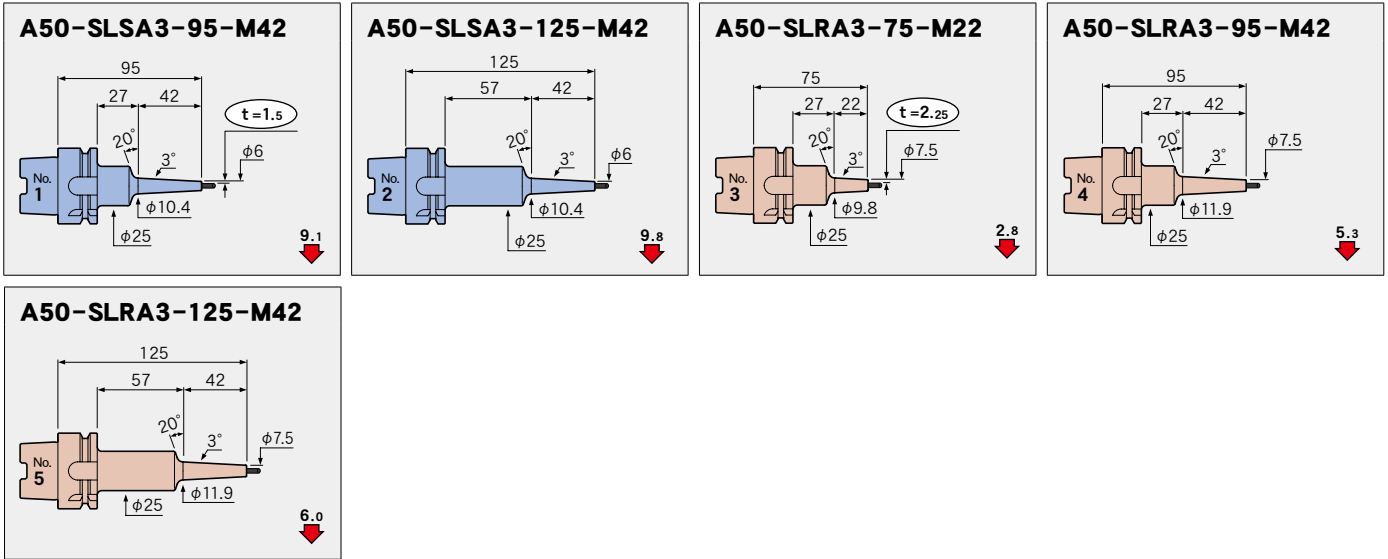

φ4

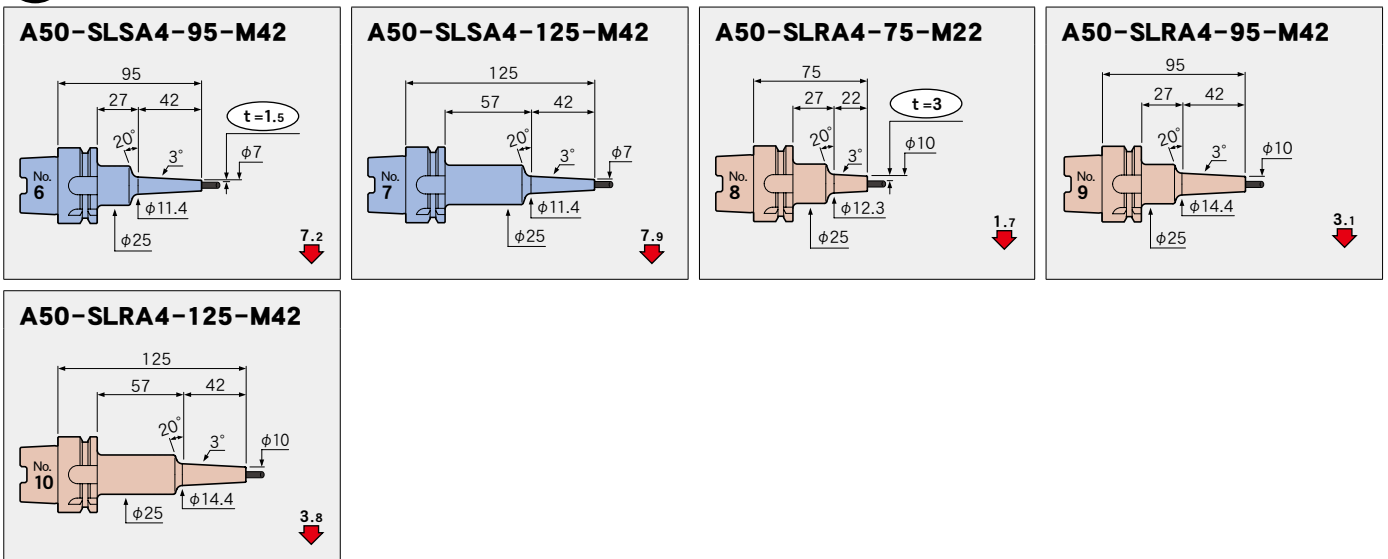

φ6

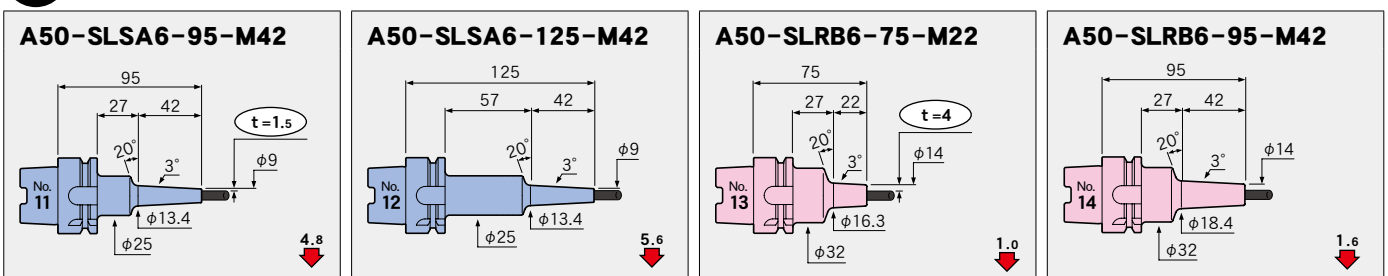

A50-SLRB6-125-M42

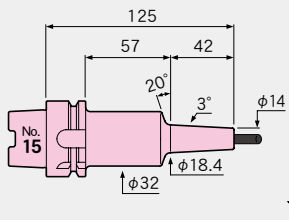

φ8

A50-SLSA8-95-M42

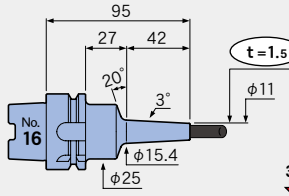

A50-SLSA8-125-M42

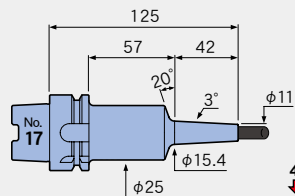

A50-SLRB8-75-M22

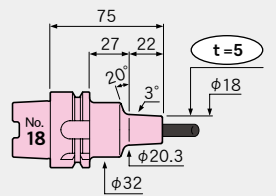

A50-SLRB8-95-M42

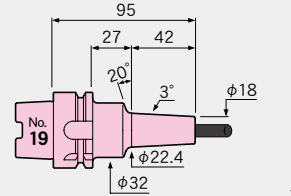

A50-SLRB8-125-M42

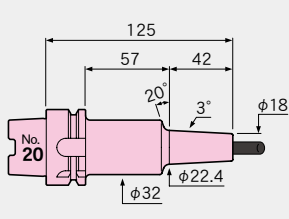

φ10

A50-SLSA10-95-M42

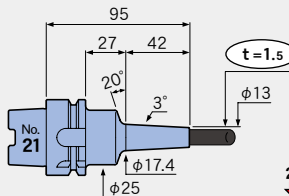

A50-SLSA10-125-M42

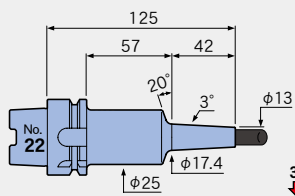

A50-SLRB10-75-M22

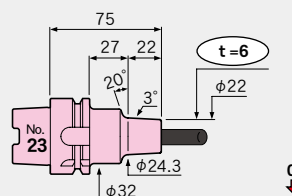

A50-SLRB10-95-M42

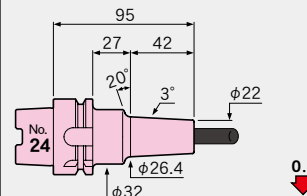

A50-SLRB10-125-M42

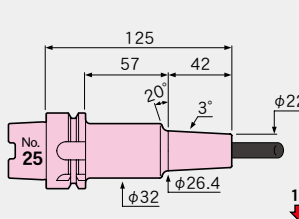

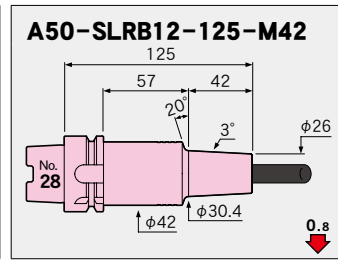
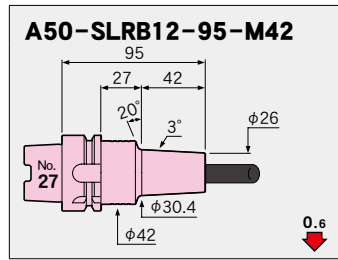
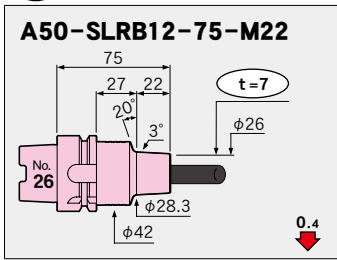
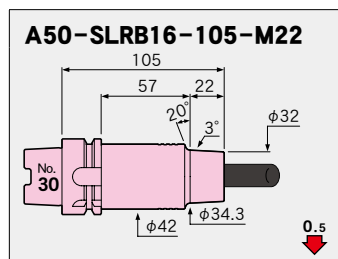
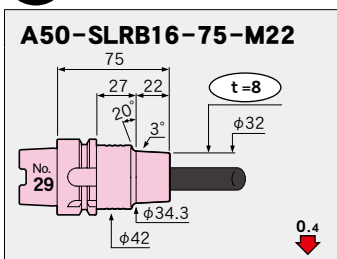
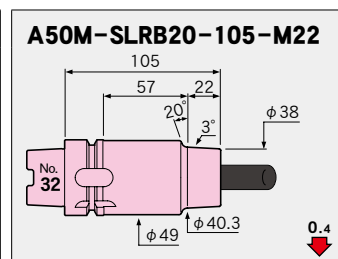
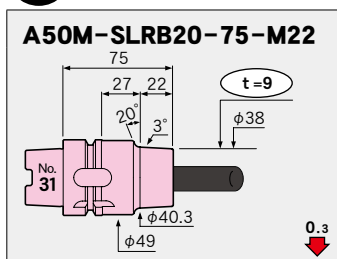
$\phi 12$  $\phi 16$  $\phi 20$ 

思诚资源
www.sczy.com
高端制造服务商

深圳思诚资源科技有限公司
SHENZHEN SCZY TECHNOLOGY CO.,LTD.

电话/Tel: 0769-22186189

网址/Web: www.sczy.com

邮箱/E-mail: sales@sczy.com

地址/Adr: 广东省东莞市长安镇长青南路1号万科中心1906



微信公众平台